



KATALOG OGRADE

FENCES CATALOG





MODERNE ALUMINIJSKE OGRADE

APSOLUTNI HIT NA TRŽIŠTU!

Izrađuje se od kvalitetnih aluminijskih profila, estetskog i modernog oblika te omogućava veliku kreativnost u izradi.

Također, ograde izrađujemo po želji naših kupaca uz predočenje primjera željenog modela.



MOGUĆNOST OGRAĐIVANJA

- Dvorišta
- Balkona
- Terasa
- Stepeništa...

PREDNOSTI ALUMINIJSKIH OGRADA

- Dug vijek trajanja
- Antikorozivna svojstva
- Lakoća održavanja
- Mogućnost plastifikacije u svim bojama po ljestvici RAL-a • Stepeništa...



OGRADE RADIMO PO PRINCIPU PONUDE

U izračun cijena ulazi:

- Broj, oblik, širina i dimenzije horizontalnih letvica
- Dimenzije stupa (80x50 mm; 80x80 mm; 100x100 mm)
- Lokacija montaže
- Građevinska priprema za montažu

OGRADE TE 01

Fence - model TE 01

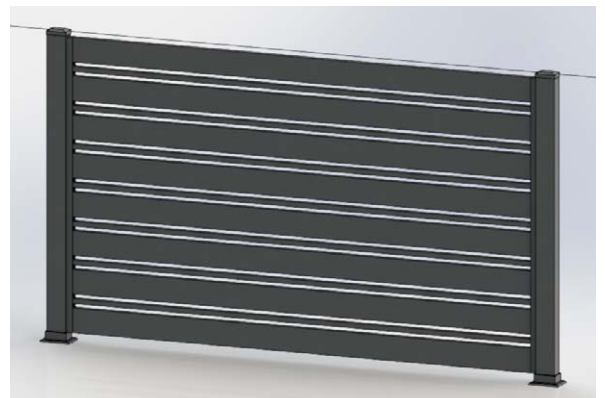
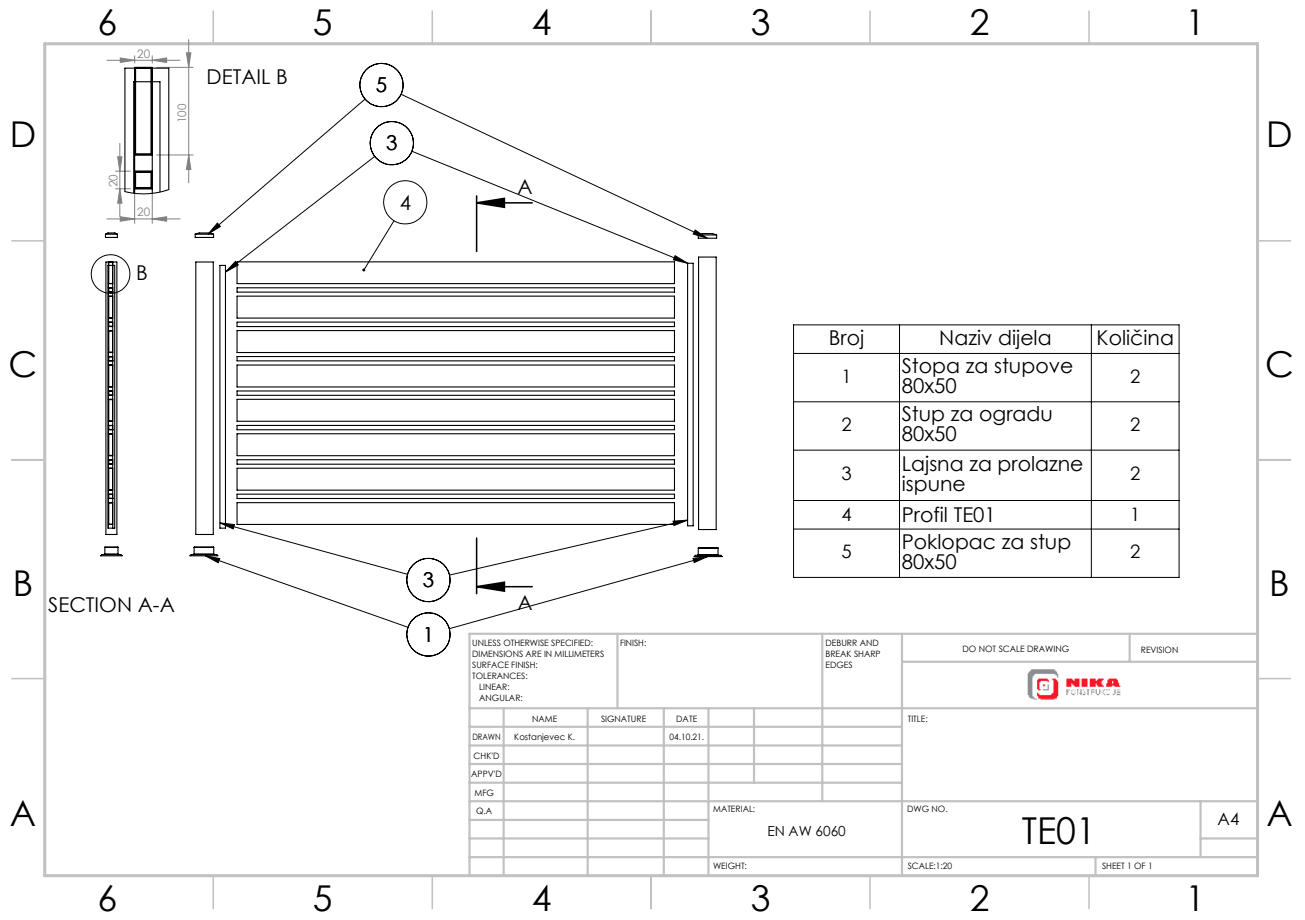



ALUMINIJSKE OGRADE



OGRADE TE 02

Fence - model TE 02

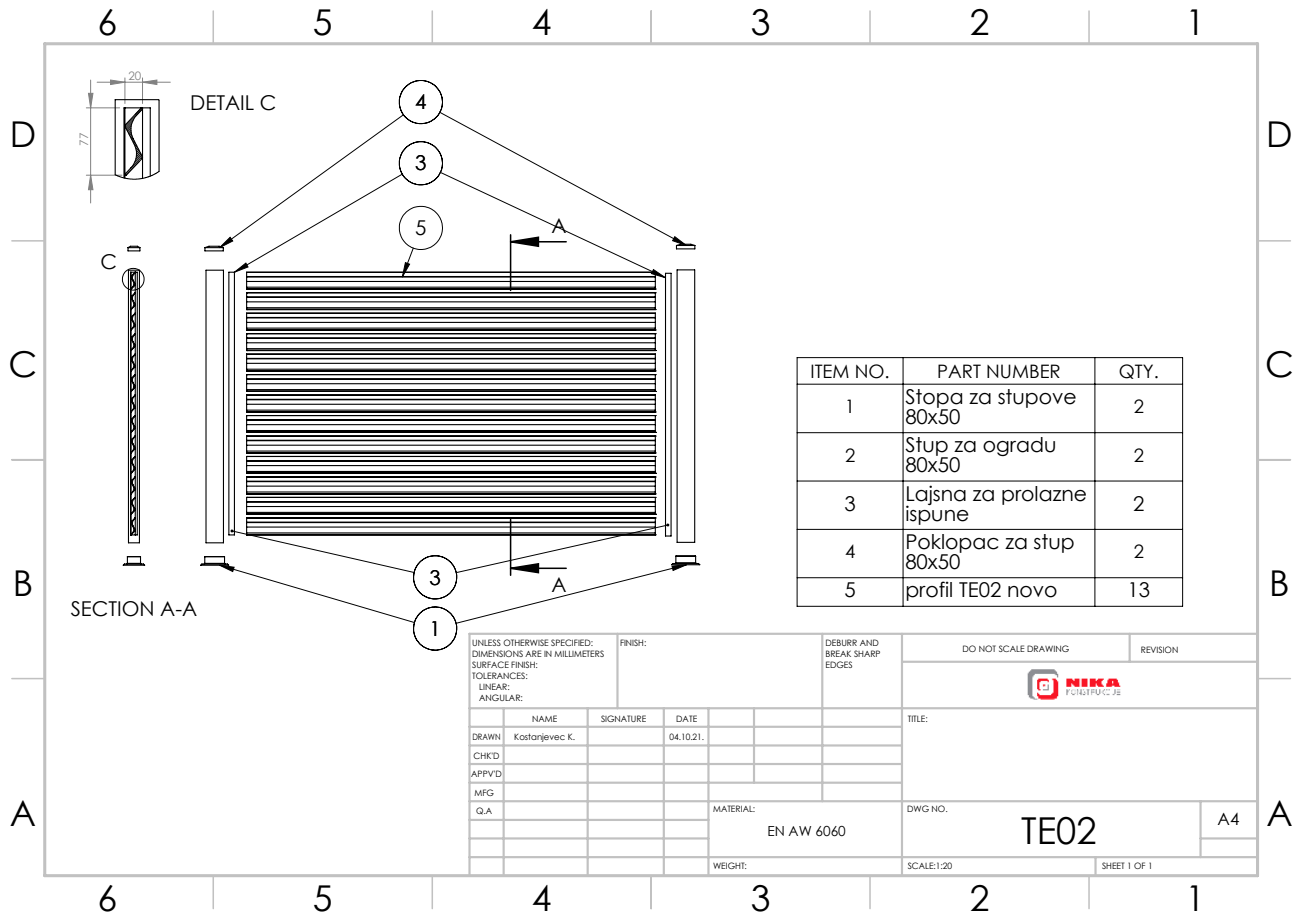

UNLESS OTHERWISE SPECIFIED: DIMENSIONS ARE IN MILLIMETERS SURFACE FINISH: TOLERANCES: LINEAR: ANGULAR:			FINISH:	DEBURR AND BREAK SHARP EDGES	DO NOT SCALE DRAWING	REVISION
DRAWN	NAME	SIGNATURE	DATE	TITLE:		
CHK'D	Kostanjevec, K.		04.10.21.			
APP'VD						
MFG				MATERIAL:	DWG NO.	
Q.A				EN AW 6060	TE02	A4
				WEIGHT:	SCALE:1:20	SHEET 1 OF 1

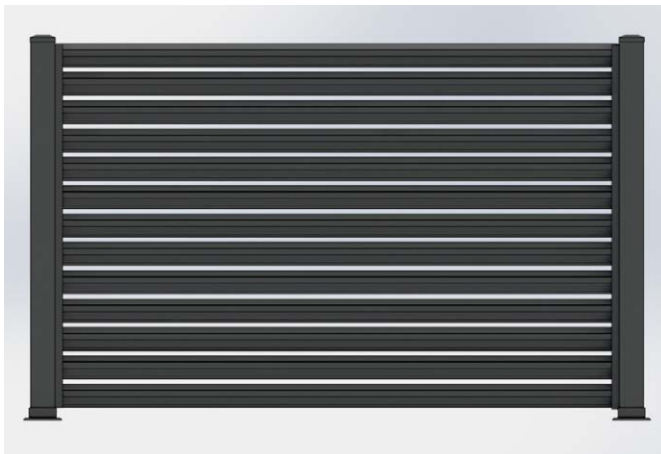
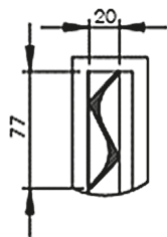



OGRADE TE 03

Fence - model TE 03

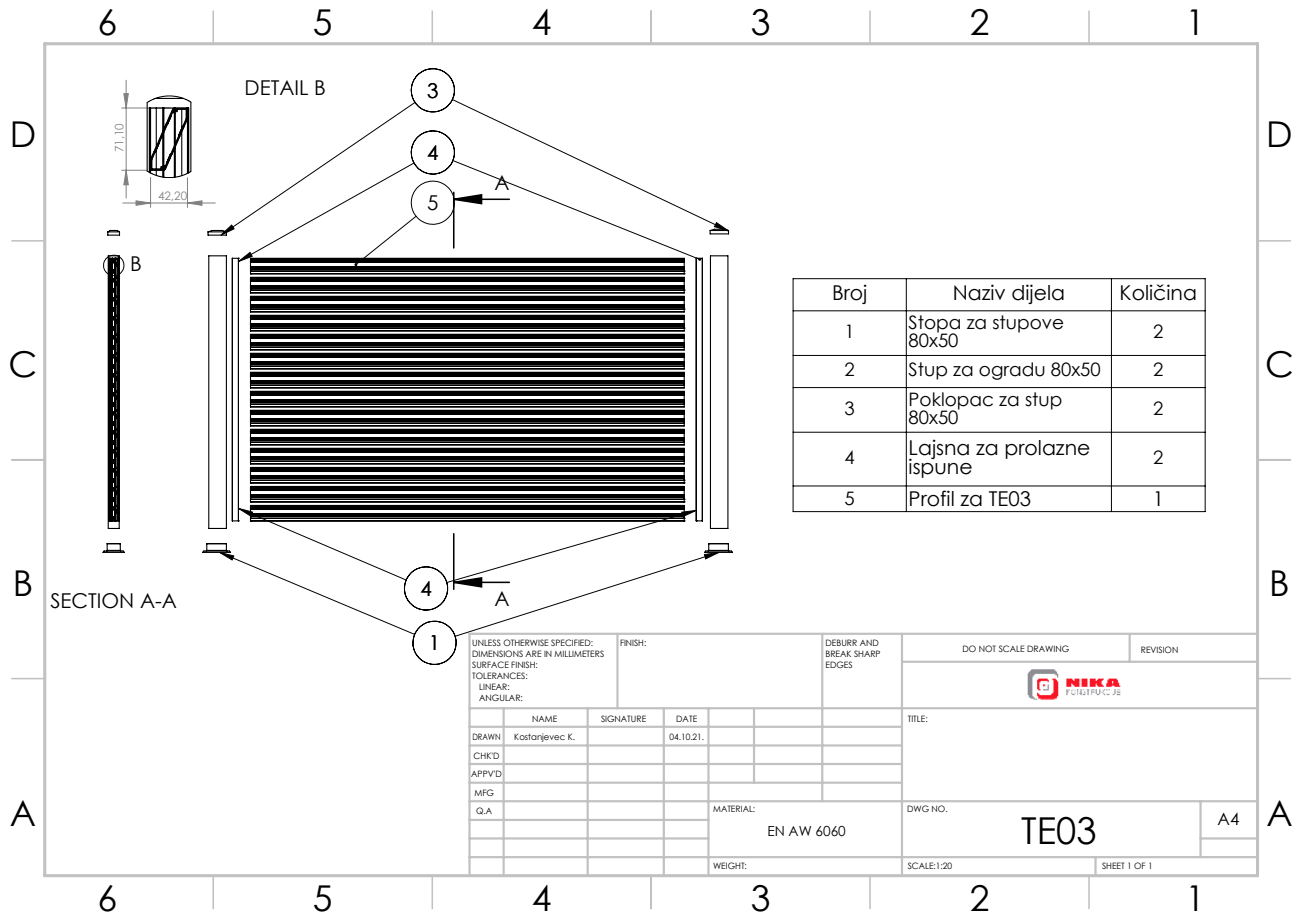

UNLESS OTHERWISE SPECIFIED: DIMENSIONS ARE IN MILLIMETERS SURFACE FINISH: TOLERANCES: LINEAR: ANGULAR:			FINISH:	DEBURR AND BREAK SHARP EDGES	DO NOT SCALE DRAWING	REVISION
DRAWN	NAME	SIGNATURE	DATE	TITLE:		
CHK'D	Kostanjevec, K.		04.10.21.			
APP'VD						
MFG				MATERIAL:	DWG NO.	
Q.A.				EN AW 6060	TE03	A4
				WEIGHT:	SCALE:1:20	SHEET 1 OF 1

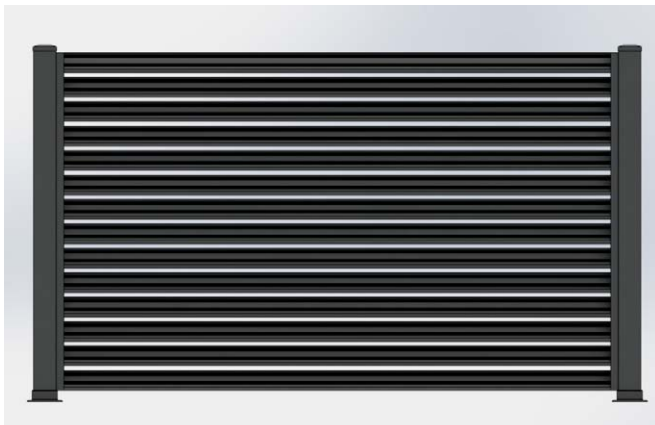
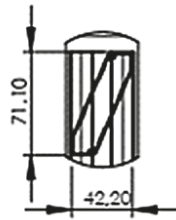



OGRADE TE 04

Fence - model TE 04

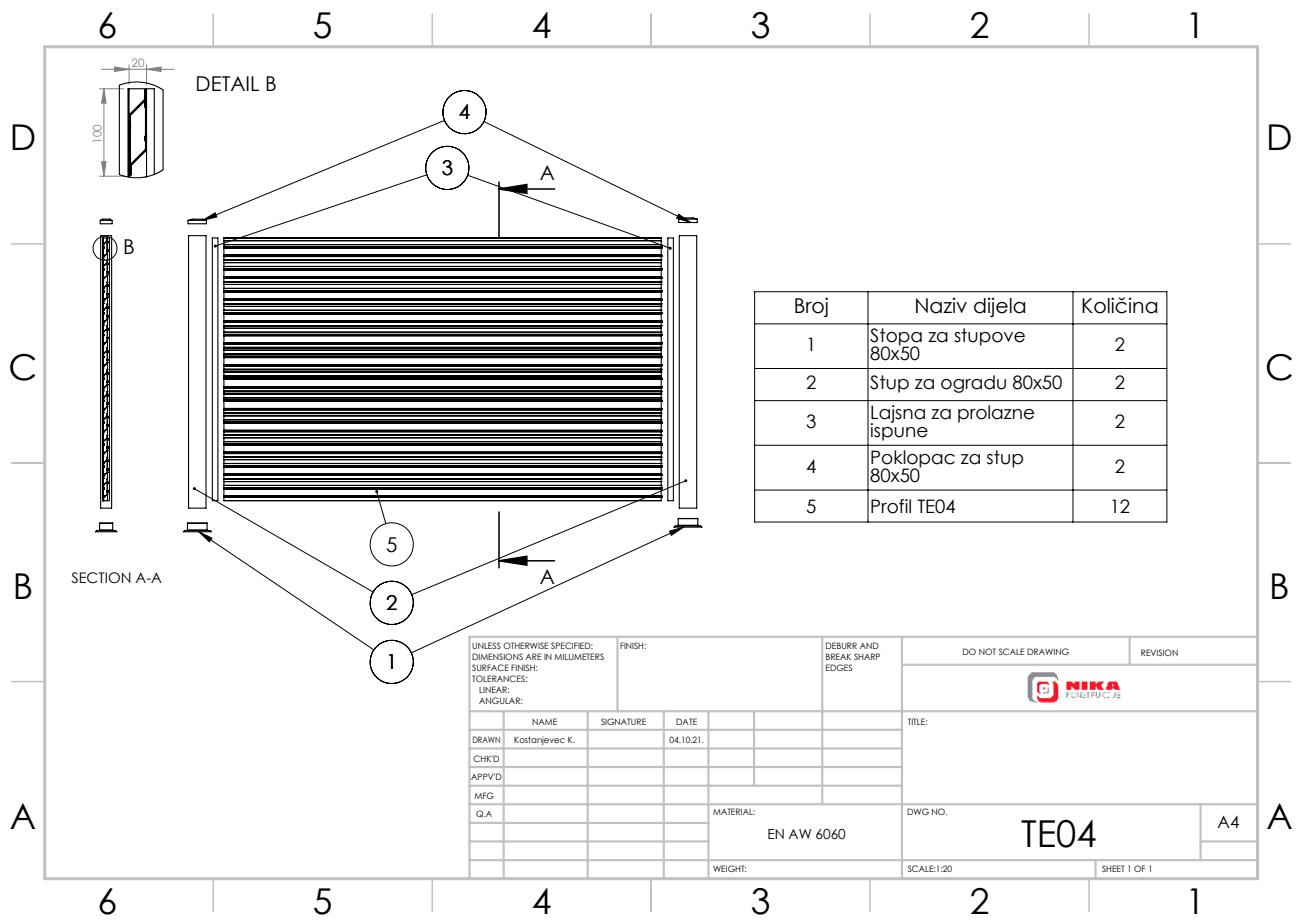

UNLESS OTHERWISE SPECIFIED: DIMENSIONS ARE IN MILLIMETERS SURFACE FINISH: TOLERANCES: LINEAR: ANGULAR:			FINISH:	DEBURR AND BREAK SHARP EDGES	DO NOT SCALE DRAWING	REVISION
DRAWN	NAME	SIGNATURE	DATE	TITLE:		
CHK'D	Kostanjevec, K.		04.10.21.	TE04		
APP'VD				MATERIAL:	DWG NO.	A4
MFG				EN AW 6060	TE04	
Q.A.				WEIGHT:	SCALE: 1:20	SHEET 1 OF 1

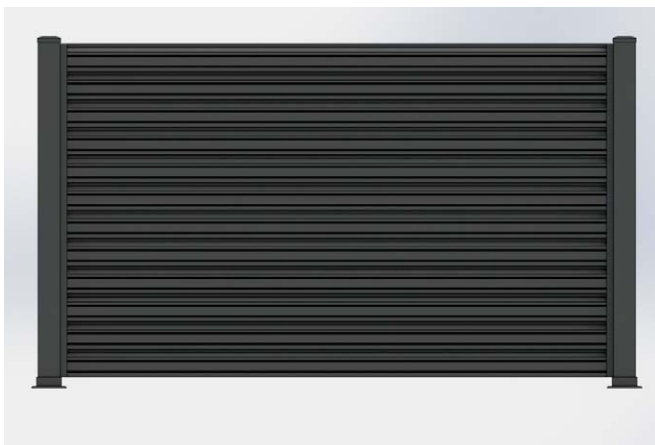
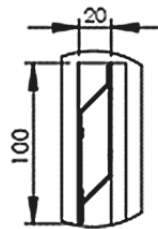



ALUMINIJSKE OGRADE

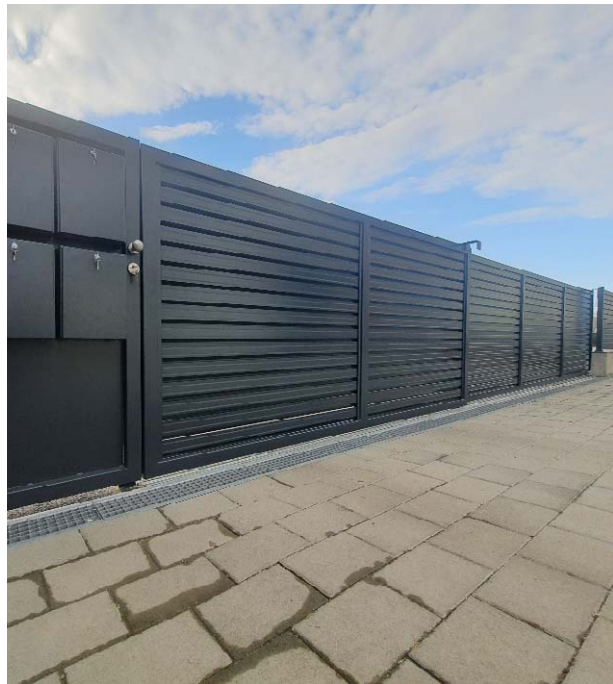

OGRADE TE 05

Fence - model TE 05

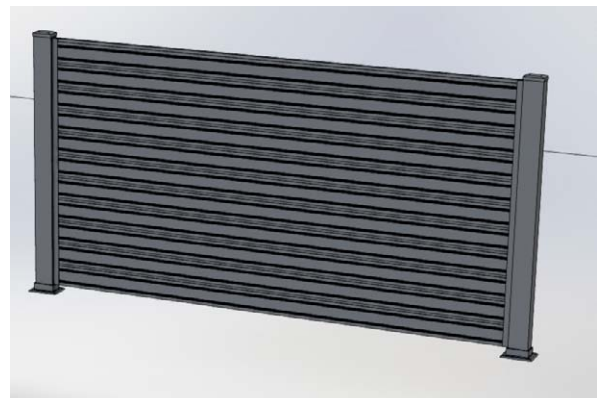
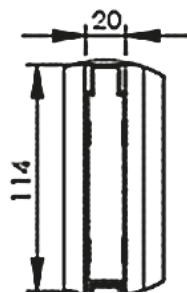
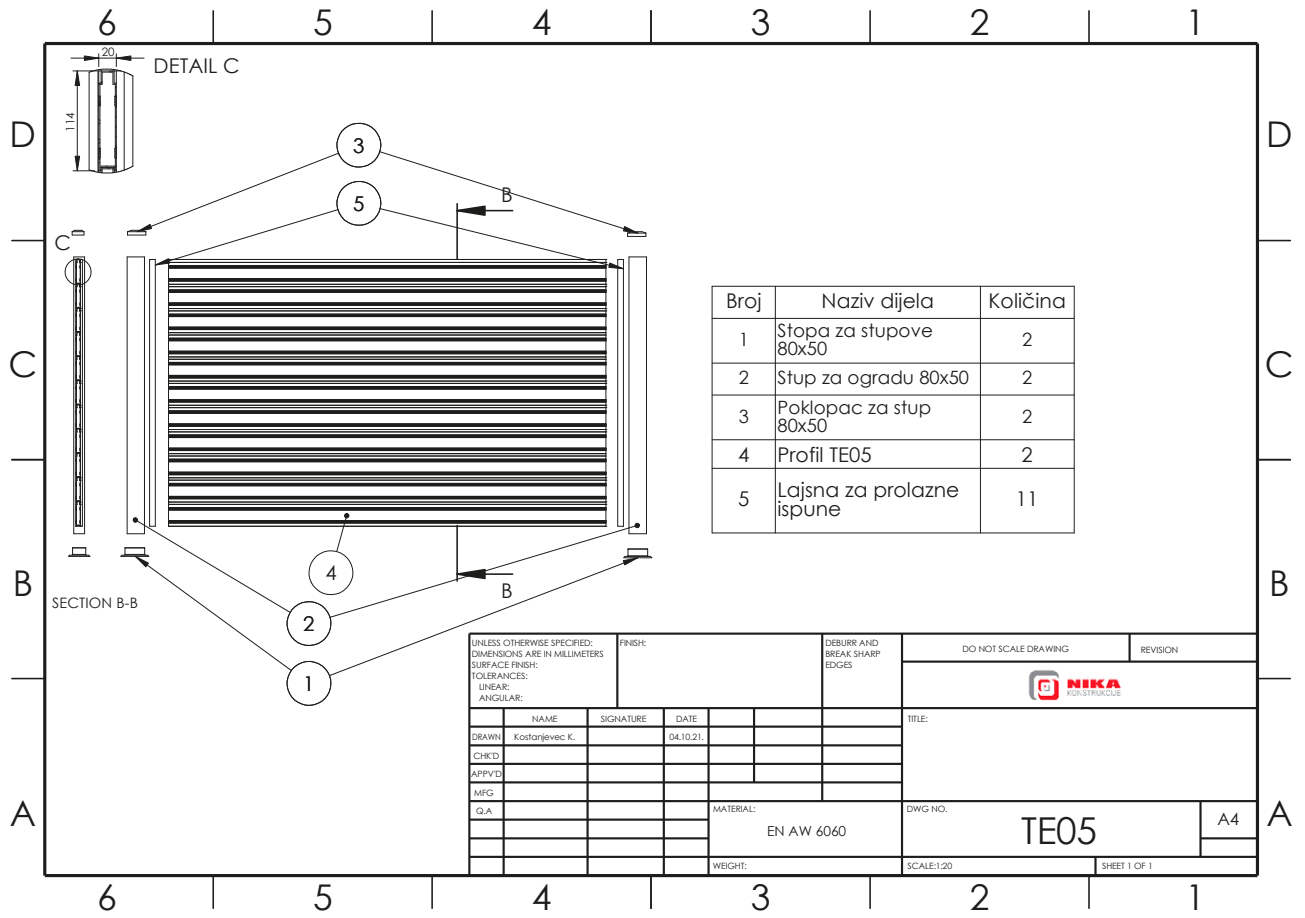

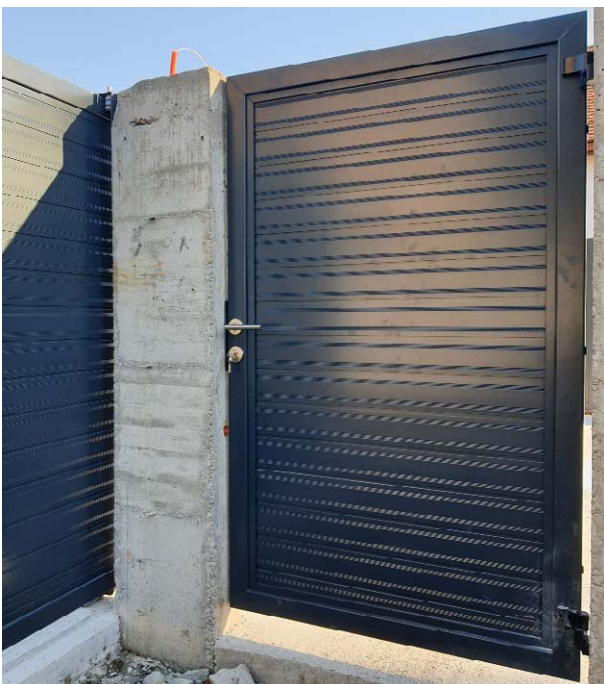

OGRADE TE 06

Fence - model TE 06

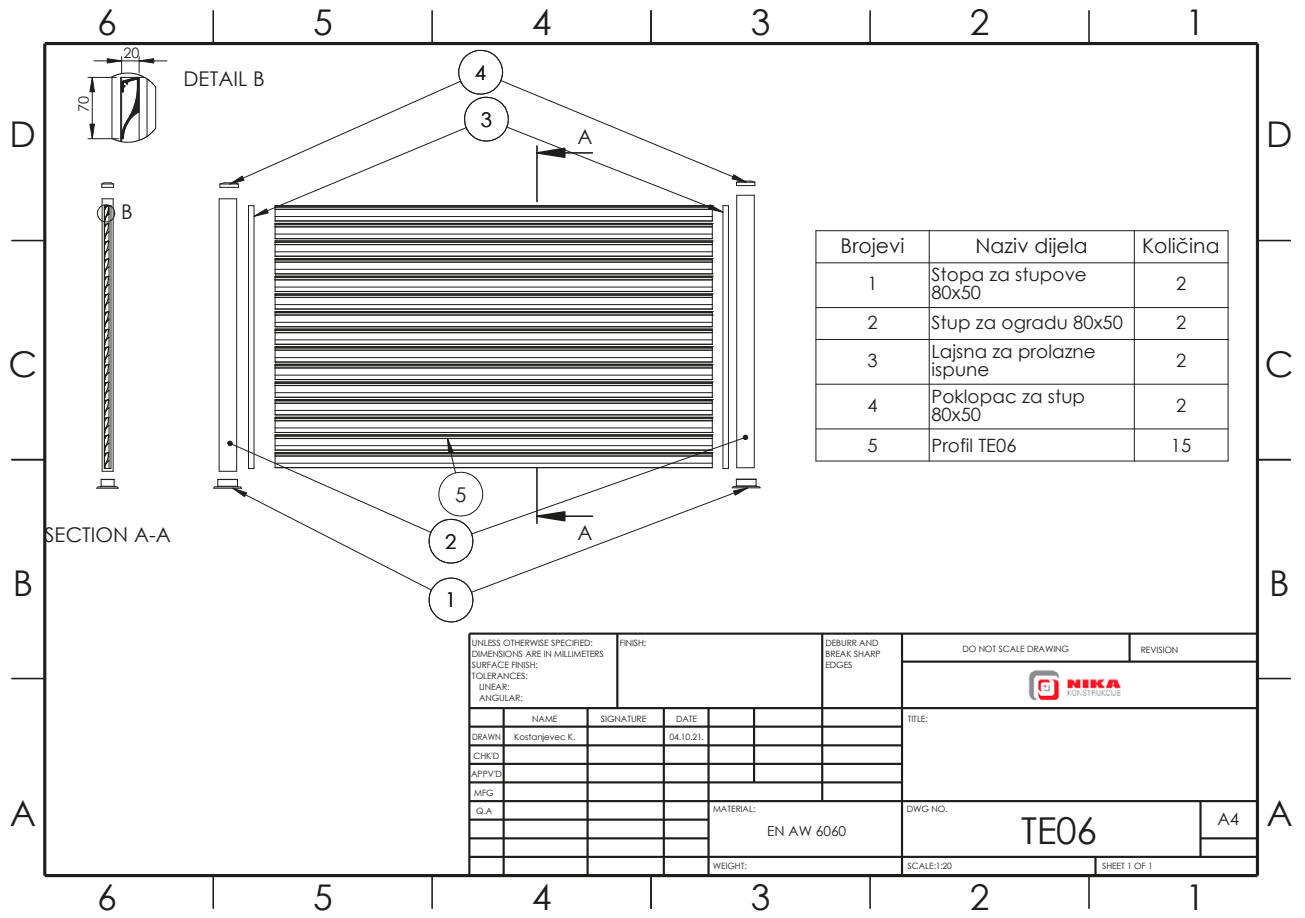

UNLESS OTHERWISE SPECIFIED: DIMENSIONS ARE IN MILLIMETERS SURFACE FINISH: TOLERANCES: LINEAR: ANGULAR:				FINISH:	DEBURR AND BREAK SHARP EDGES	DO NOT SCALE DRAWING	REVISION
DRAWN: Kostanjevec, K.				SIGNATURE:	DATE: 04.10.21.	NIKA KONSTRUKCIJE	
CHK'D:						TITLE:	
APP'D:						TE06	
MFG:					MATERIAL: EN AW 6060	DWG NO.:	A4
Q.A:					WEIGHT:	SCALE: 1:20	SHEET 1 OF 1

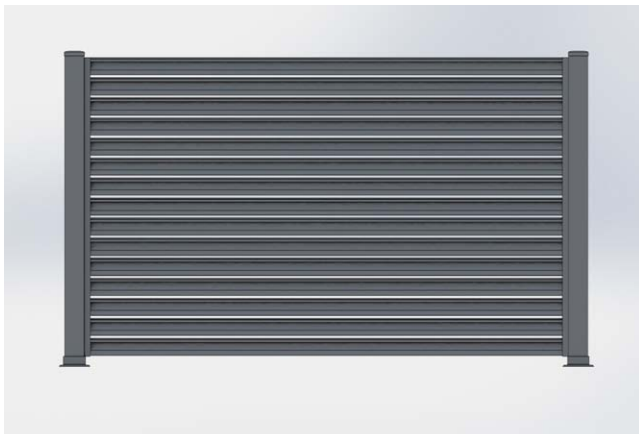
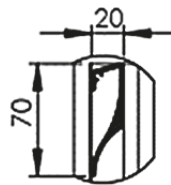



OGRADE TE 07

Fence - model TE 07

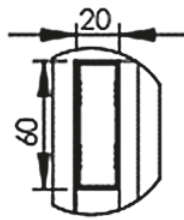
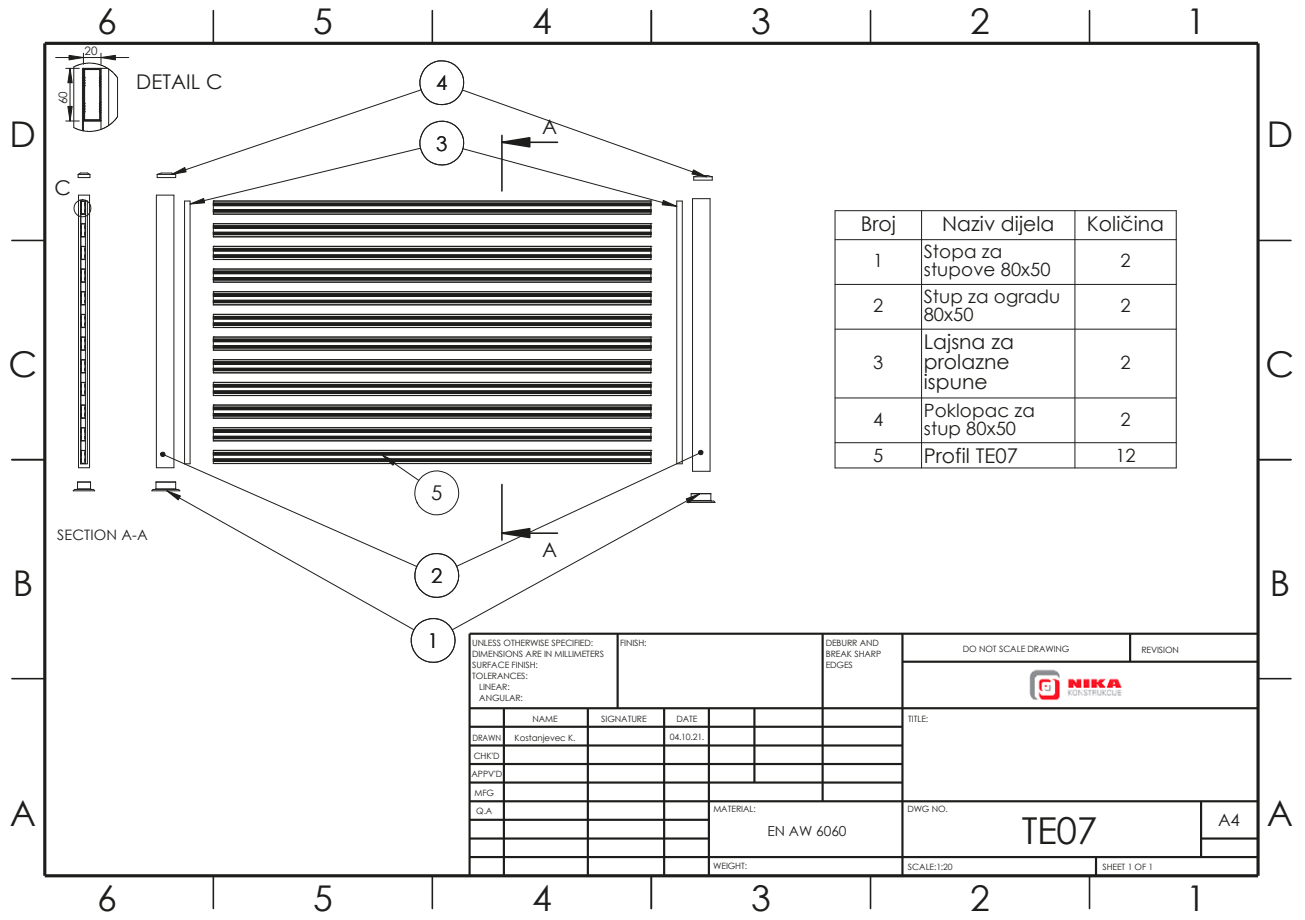



OGRADE TE 08

Fence - model TE 08

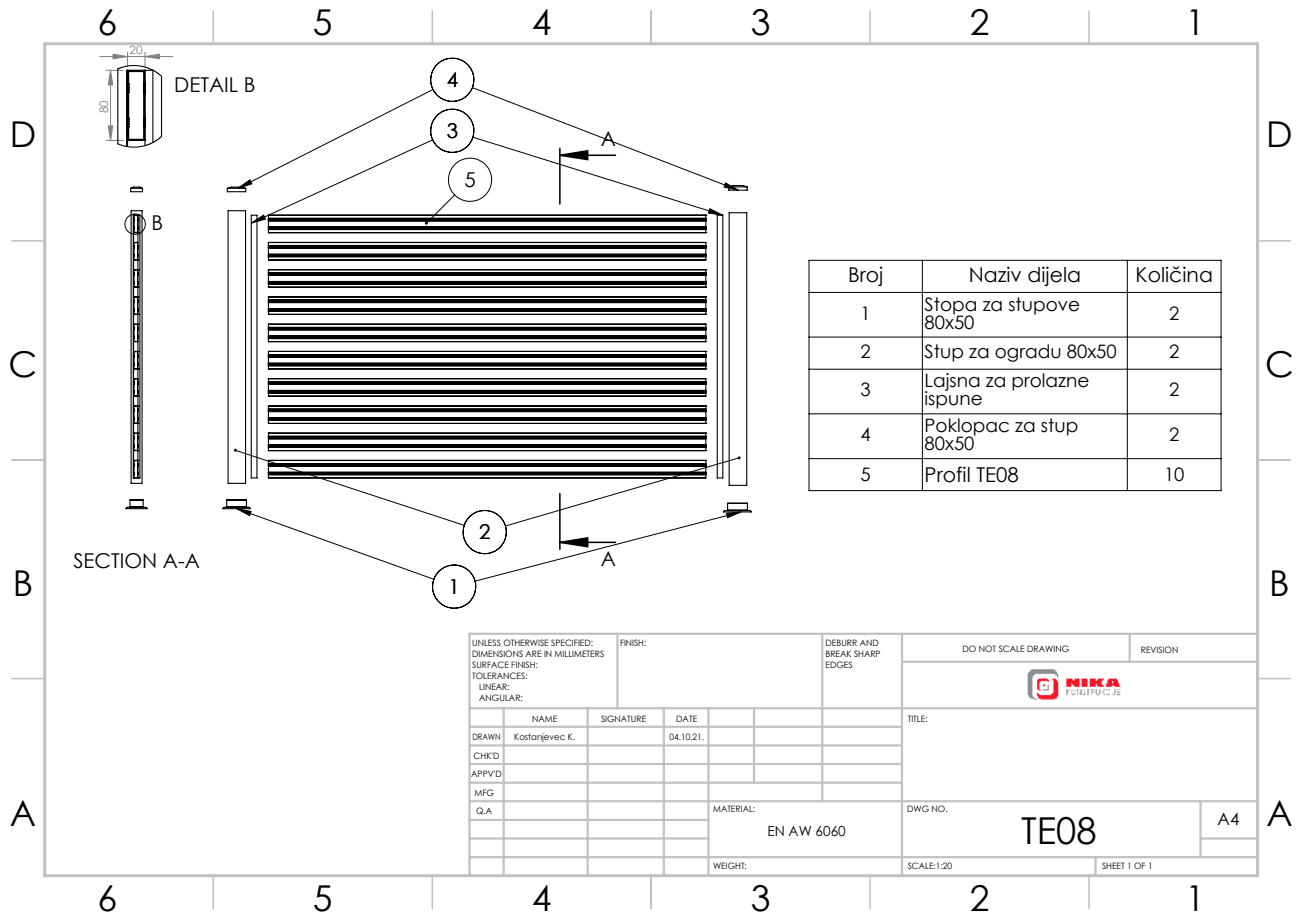

UNLESS OTHERWISE SPECIFIED: DIMENSIONS ARE IN MILLIMETERS SURFACE FINISH: TOLERANCES: LINEAR: ANGULAR:				FINISH:	DEBURR AND BREAK SHARP EDGES	DO NOT SCALE DRAWING	REVISION
DRAWN	NAME	SIGNATURE	DATE				
CHK'D	Kostanjevec, K.		04.10.21.			TITLE:	
APP'VD						DWG NO. TE08	
MFG					MATERIAL: EN AW 6060	A4	
Q.A.					WEIGHT:	SCALE: 1:20	SHEET 1 OF 1

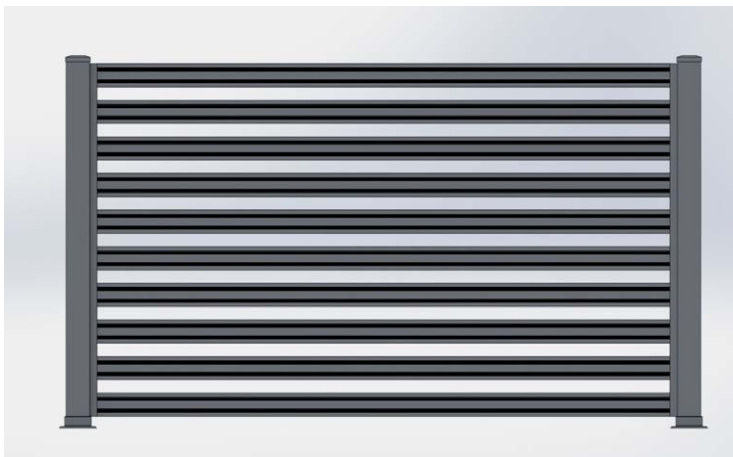
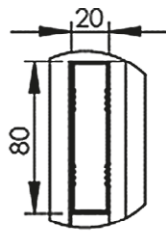

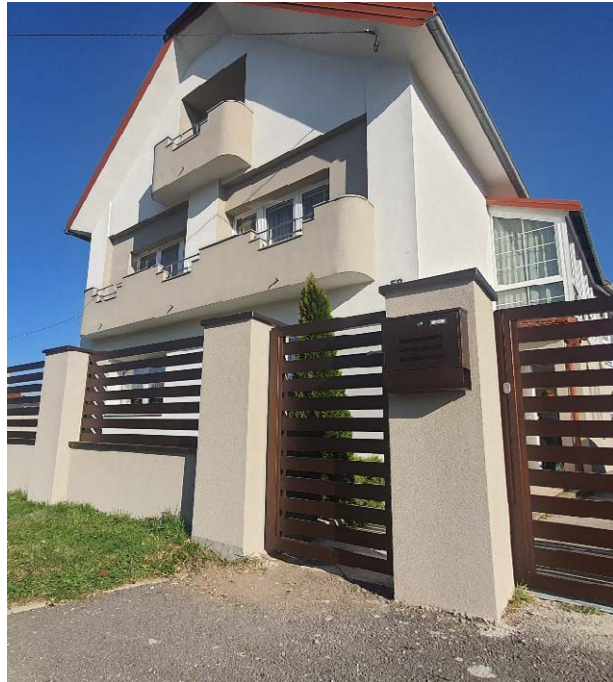

OGRADE TE 09

Fence - model TE 09

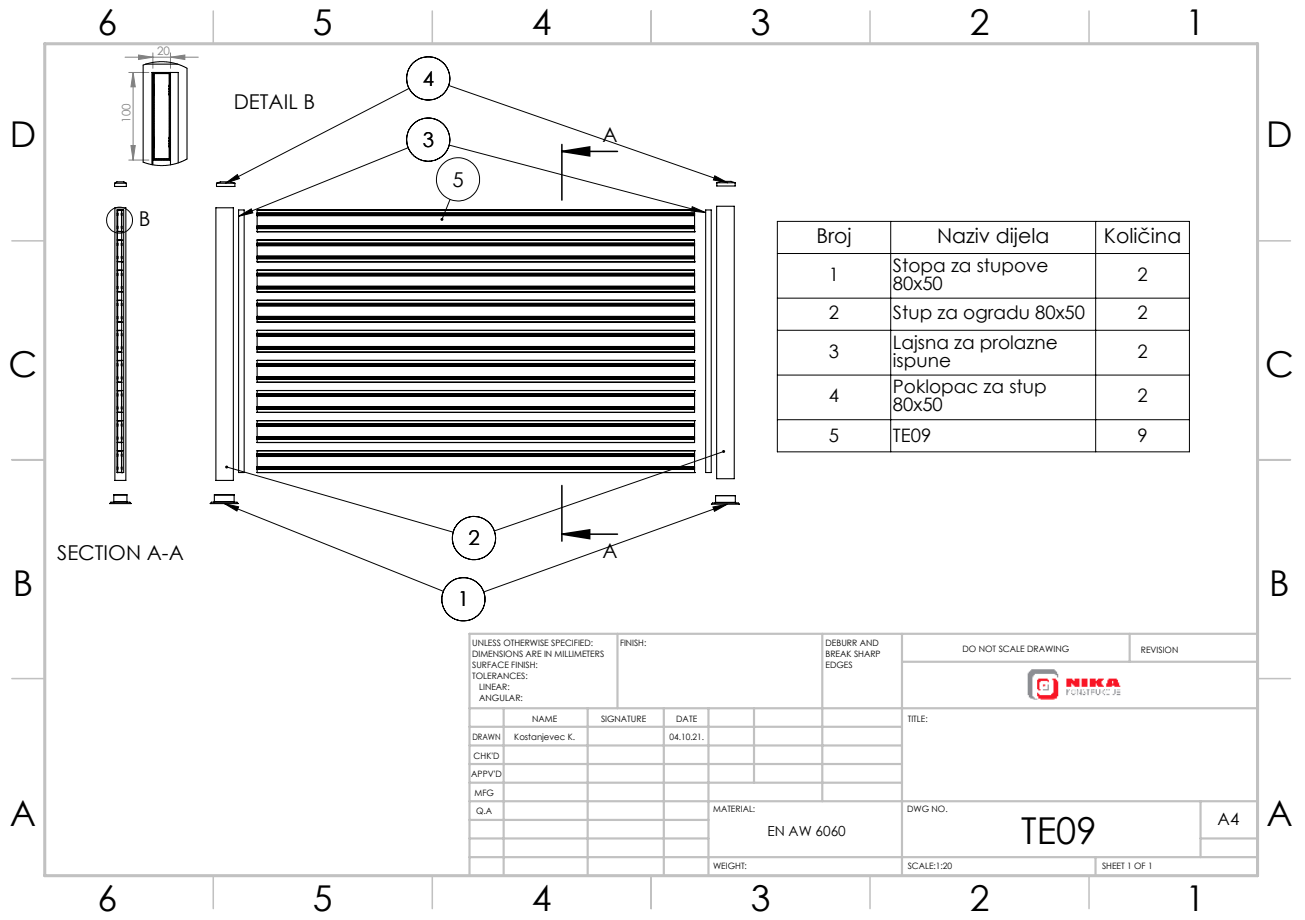

UNLESS OTHERWISE SPECIFIED: DIMENSIONS ARE IN MILLIMETERS SURFACE FINISH: TOLERANCES: LINEAR: ANGULAR:			FINISH:	DEBURR AND BREAK SHARP EDGES	DO NOT SCALE DRAWING	REVISION
DRAWN	NAME	SIGNATURE	DATE	TITLE:		
CHK'D	Kostanjevec, K.		04.10.21.			
APP'VD						
MFG				MATERIAL:	DWG NO.	
Q.A.				EN AW 6060	TE09	A4
				WEIGHT:	SCALE:1:20	SHEET 1 OF 1

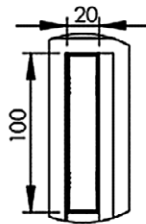



OGRADE TE 10

Fence - model TE 10

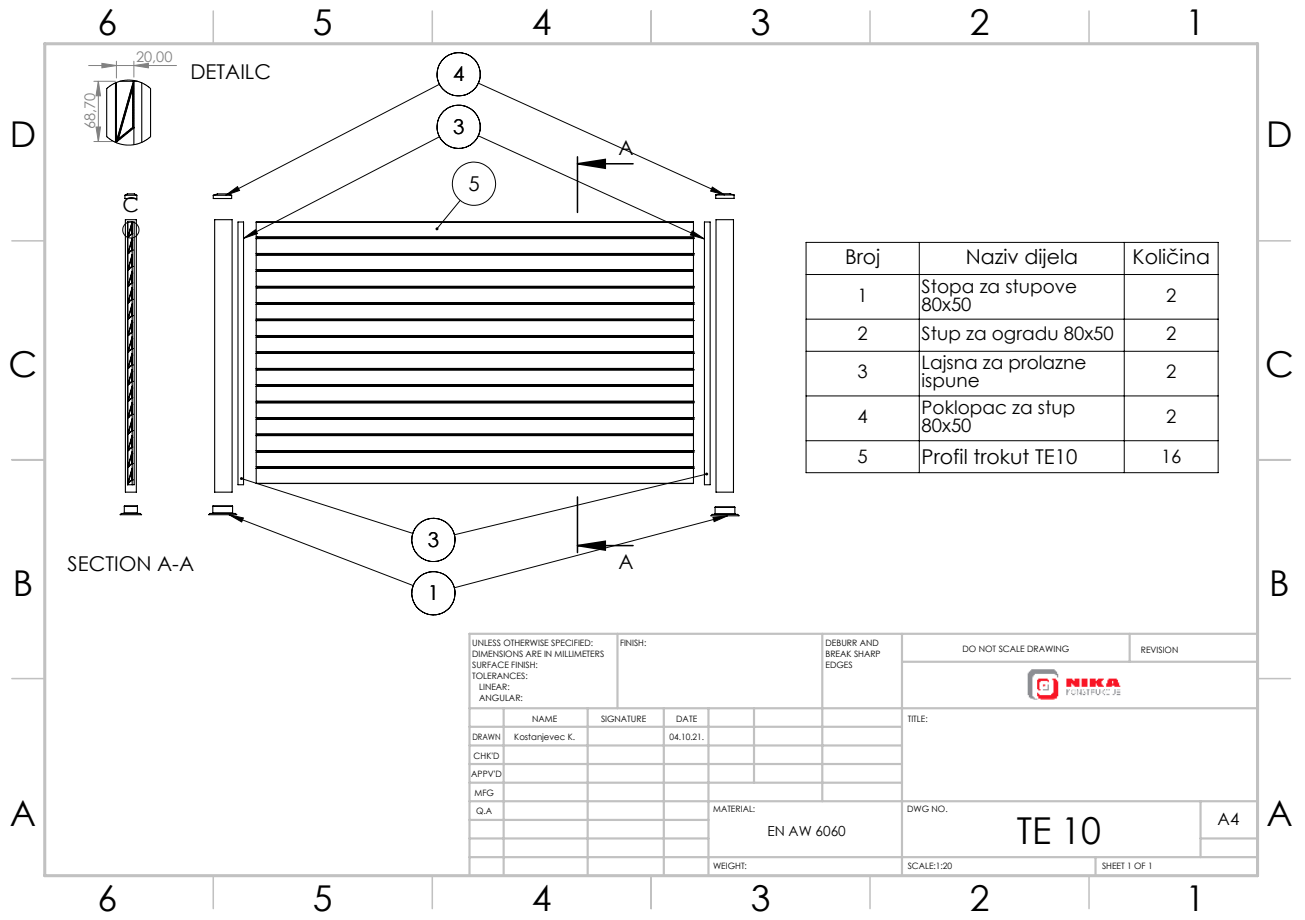

UNLESS OTHERWISE SPECIFIED: DIMENSIONS ARE IN MILLIMETERS SURFACE FINISH: TOLERANCES: LINEAR: ANGULAR:			FINISH:	DEBURR AND BREAK SHARP EDGES	DO NOT SCALE DRAWING	REVISION
DRAWN	NAME	SIGNATURE	DATE	TITLE:		
CHK'D	Kostanjevec, K.		04.10.21.			
APP'VD						
MFG				MATERIAL:	DWG NO.	
Q.A.				EN AW 6060	TE 10	A4
				WEIGHT:	SCALE:1:20	SHEET 1 OF 1

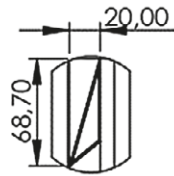

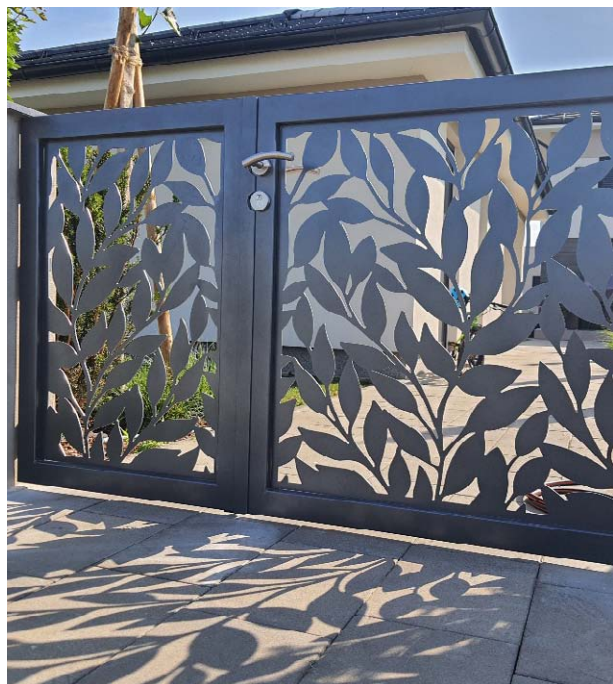



NIKA
KONSTRUKCIJE

Ulica Braće Radića 23
42206, Petrijanec, Hrvatska

tel/fax: +385 42 303 166
tel: +385 42 303 167

e-mail: info@nika-konstrukcije.hr
web: www.nika-konstrukcije.hr